

Overdenture Laboratory Technique

Assemble screw driver with
Thumb Knob

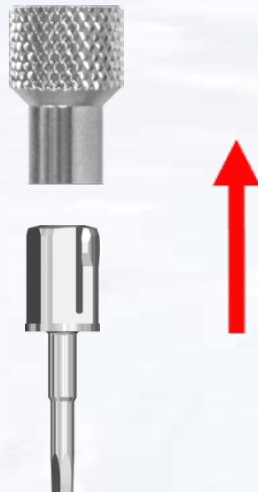

Remove healing abutment
from implant

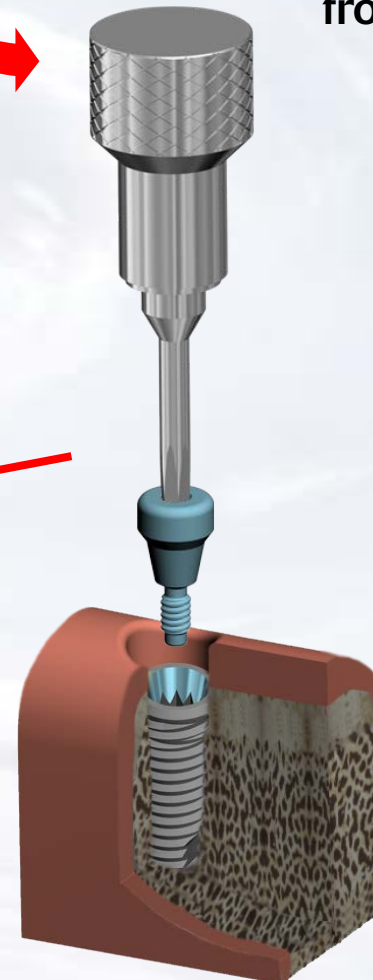

Blue Sky Bio

Overdenture Laboratory Technique

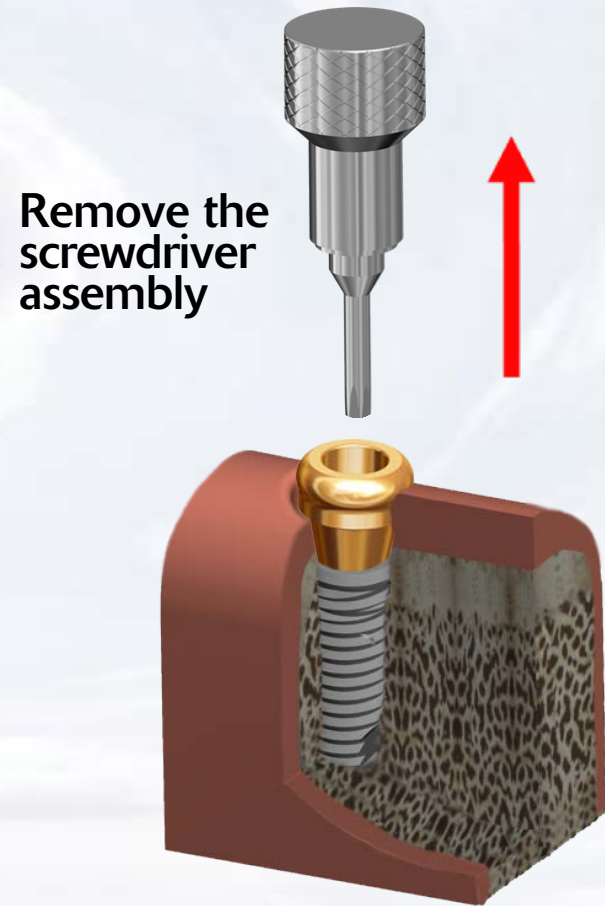
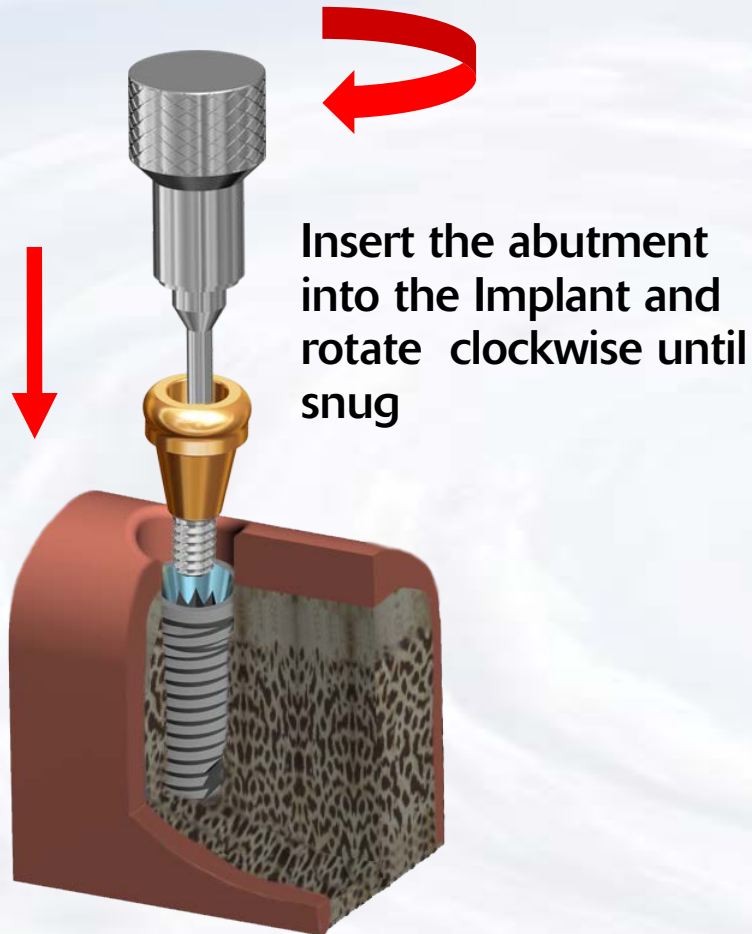

Blue Sky Bio

Overdenture Laboratory Technique



Insert the Hex Driver within the 30Ncm torque ratchet

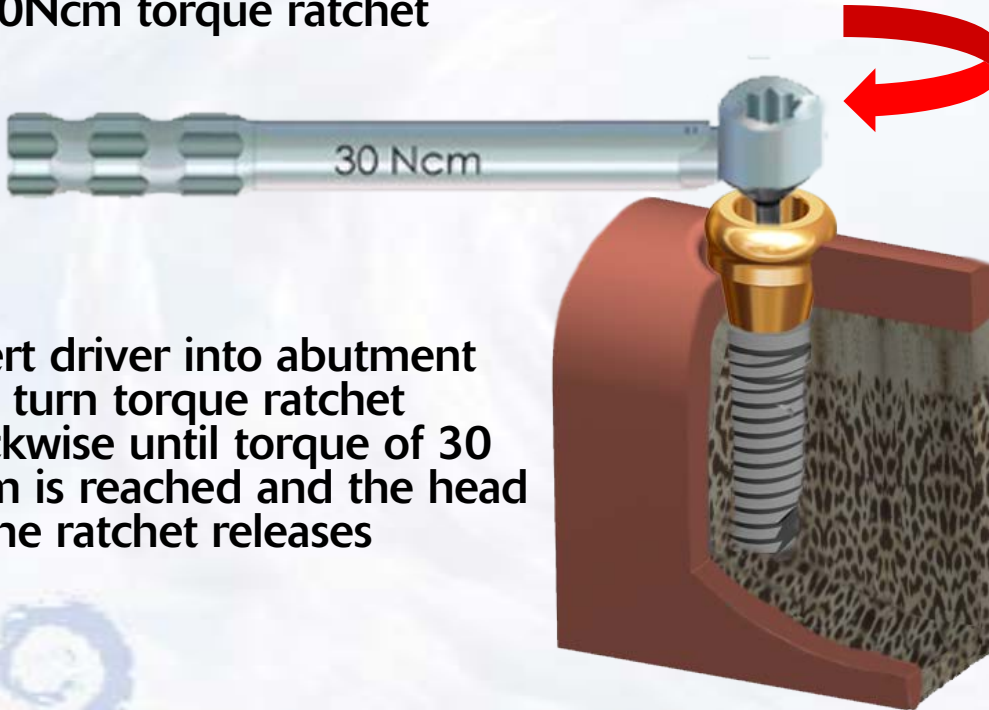

Insert driver into abutment and turn torque ratchet clockwise until torque of 30 Ncm is reached and the head of the ratchet releases

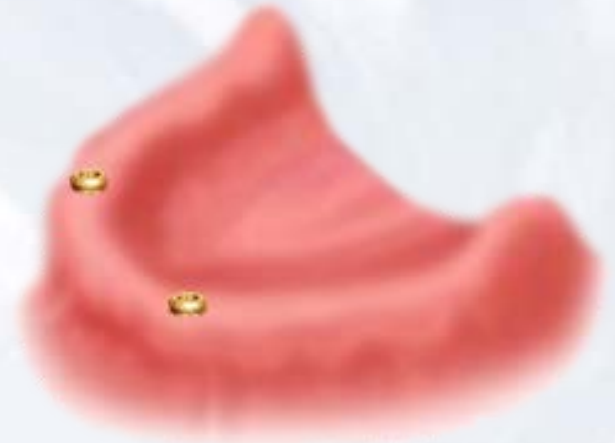

Abutments in place



Blue Sky Bio

Overdenture Laboratory Technique

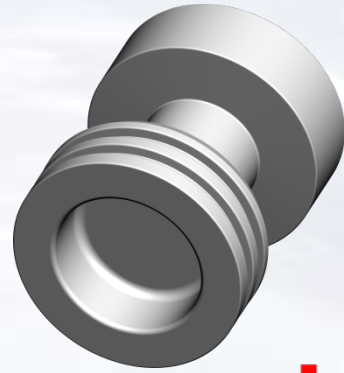

Snap impression transfer
on the abutments

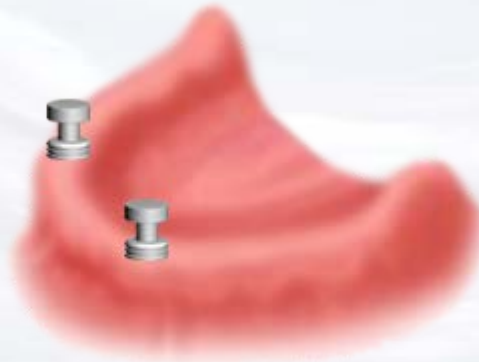

Blue Sky Bio

Overdenture Laboratory Technique

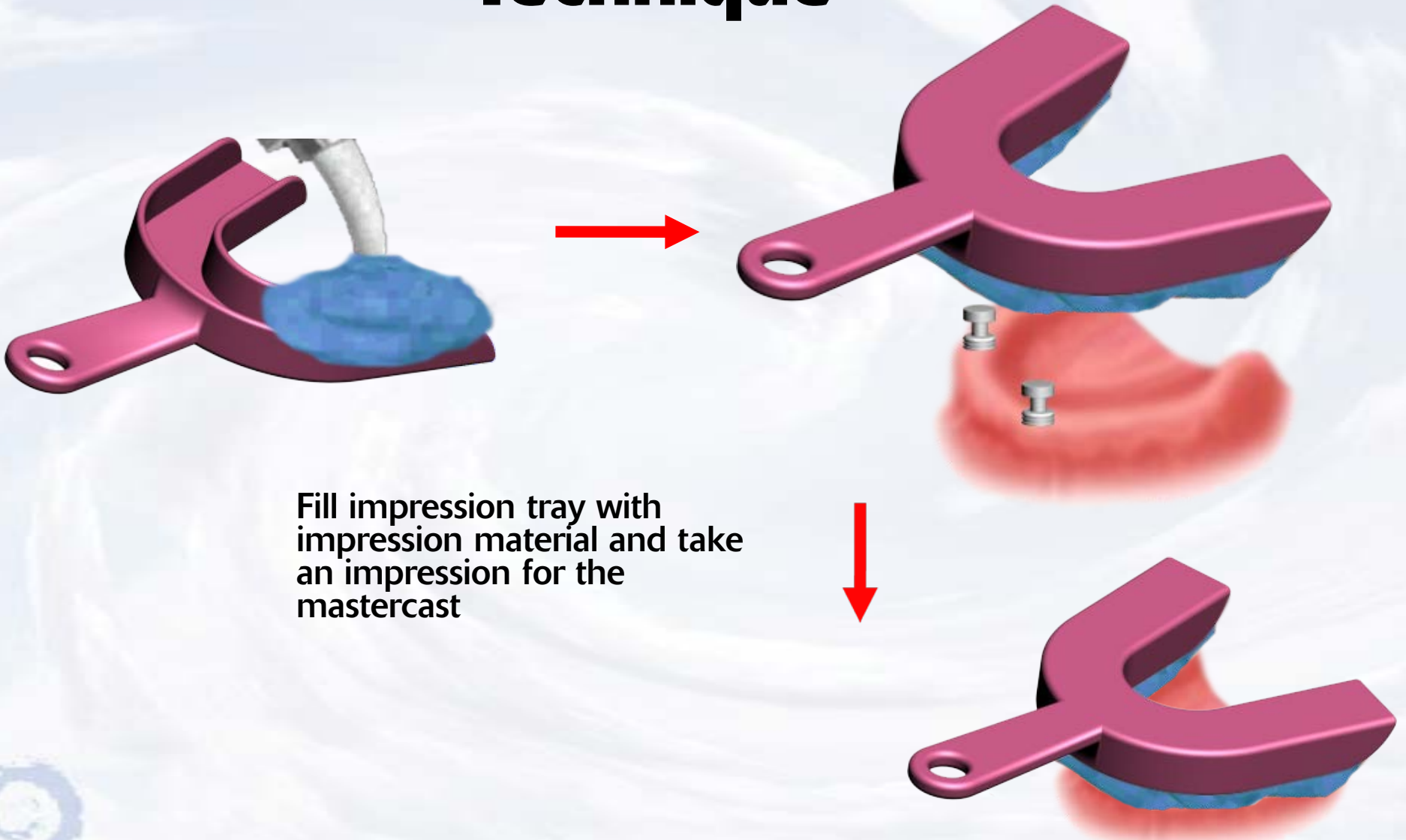

Fill impression tray with impression material and take an impression for the mastercast



Blue Sky Bio

Overdenture Laboratory Technique



After impression material has set remove impression from mouth picking up the impression transfers

Snap analogs into the impression transfers



Blue Sky Bio

Overdenture Laboratory Technique



Pour impression with model stone and make master cast with analogs in place



Blue Sky Bio

Overdenture Laboratory Technique



Place black processing insert on the insertion tool

Snap black processing insert into metal housing



Blue Sky Bio

Overdenture Laboratory Technique



Place housings with processing insert on the analogs and process the denture



Blue Sky Bio

Overdenture Laboratory Technique



Remove the black processing insert with the sharp point of the removal instrument



Place the insert with the desired retention into the housing



Blue Sky Bio

Overdenture Laboratory Technique



Finished prosthesis with
housings and inserts in place



Blue Sky Bio